



Item No.	Page	Item No.	Page
----------	------	----------	------

Neon strip light

GU0410-SIDE	P1
GU0612-SIDE	P2
GU0713-SIDE	P3
GU1010-180D	P4
GU1010-TOP	P5
GU1010-SIDE	P6
GU1212-TOP	P7
GU1212-SIDE	P8
GU1220-SIDE	P9
GU1515-TOP	P10
GU1515-SIDE	P11
GU1617-SIDE	P12
GU2014-TOP	P13
GUD270-ROUND	P14
GUD360-ROUND	P15
GUC1616	P16
GU1307R	P17
GU1225-SIDE	P18
GU3D1616	P19

Cover

GU-N1010	P20
GU-N1212	P21
GU-N1616-YT	P22
GU-N1616	P23
GU-N2010	P24
GU-N2010-B	P25
GU-N2010-C	P26
GU-N2020-YT	P27
GU-N2020-B	P28
GU-N2520	P29
GU-N3020	P30
GU-N4020	P31
GU-N5015	P32
Ad tube-8	P33

COB strip light

FOB384-5MM	P35
FOB384-8MM	P36
FOB480-8MM	P37
FOB528-10MM	P38
FOB608	P39
FOB756	P40
FOB768	P40

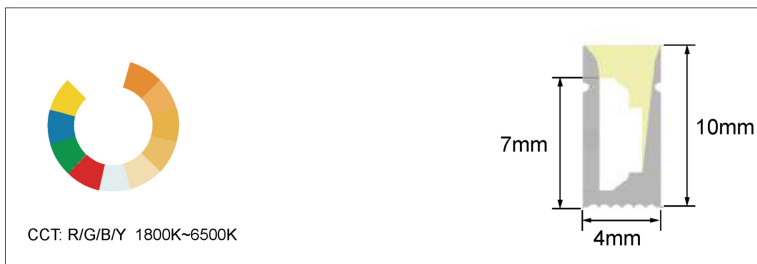

GU0410-SIDE

CE RoHS FC IC
Europe/US/Canada

Basic Parameters(Standard)

Size:	5000*4*10mm	CRI:	>90
Cutting Unit:	50mm	CCT:	1800K/2700K/3000K/4000K/6500K
Input Voltage:	DC24V	Lumen/M:	650lm/m
Input Current:	0.4A per meter	Lumen/W:	68lm/w
Power:	9.6W/M	LED Qty:	120LEDs/m
Bend Diameter:	30mm	IP Class:	IP65

Optical Parameters(led strip inside)

P/N	Power/m	Qty(LED per meter)	Cutting Unit(mm)
2835-120-24V	9.6	120	50

Clips

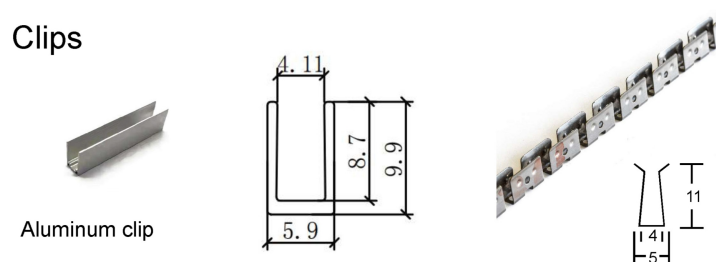

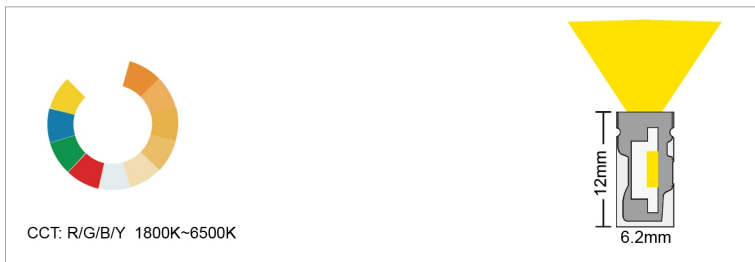

GU0612-SIDE

CE RoHS FC IC
Europe/US/Canada

Basic Parameters(Standard)

Size:	5000*6.2*12mm	CRI:	>90
Cutting Unit:	50mm	CCT:	1800K/2700K/3000K/4000K/6500K
Input Voltage:	DC24V	Lumen/M:	400lm/m
Input Current:	0.25A/m	Lumen/W	67lm/w
Power:	6W/M	LED Qty:	120LEDs/m
Bend Diameter:	30mm	IP Class:	IP65

Optical Parameters(led strip inside)

P/N	Power/m	Qty(LED per meter)	Cutting Unit(mm)
2835-60-24V	4.8	60	100
2835-120-24V	6	120	50

Clips

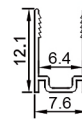

U12 Aluminum clip



S-Stainless steel clip

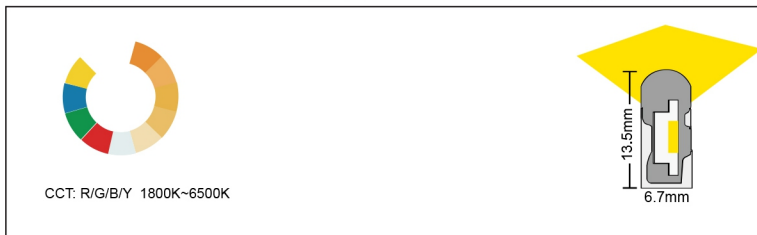
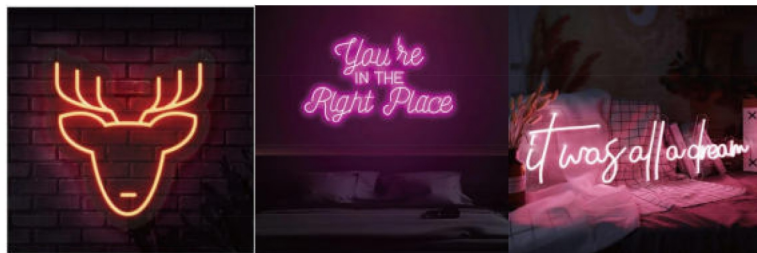

GU0713-SIDE

CE RoHS FC IC
Europe/US/Canada

Basic Parameters(Standard)

Size:	5000*6.7*13.5mm	CRI:	>90
Cutting Unit:	50mm	CCT:	4000K
Input Voltage:	DC24V	Lumen/M:	400lm/m
Input Current:	0.25A per meter	Lumen/W	67lm/w
Power:	6W/M	LED Qty:	120LEDs/m
Bend Diameter:	30mm	IP Class:	IP65

Optical Parameters(led strip inside)

P/N	Power/m	Qty(LED per meter)	Cutting Unit(mm)
2835-60-24V	4.8	60	100
2835-120-24V	6	120	50

Clips

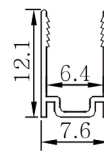

Aluminum clip



Stainless steel clip

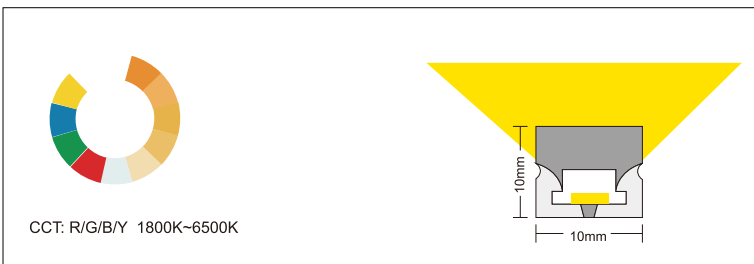

GU1010-180D

wide angle/three lighting surface



Basic Parameters(Standard)

Size:	5000*10*10mm	CRI:	>80
Cutting Unit:	50mm/100mm	CCT:	2700K/3000K/4000K/6500K
Input Voltage:	DC24V	Lumen/M:	650lm/m
Input Current:	0.4A per meter	Lumen/W	67lm/w
Power:	9.6W/M	LED Qty:	120LEDs/m
Bend Diameter:	30mm	IP Class:	IP67

Optical Parameters(led strip inside)

P/N	Power/m	Qty(LED per meter)	Cutting Unit(mm)
2835-120-24V	9.6	120	50

Clips

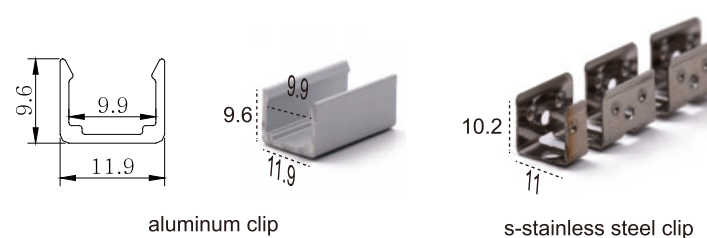

aluminum clip

s-stainless steel clip

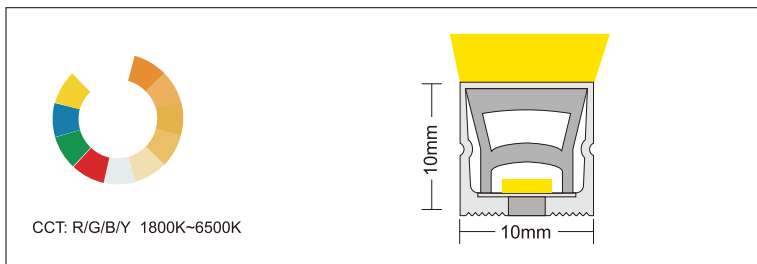

GU1010-TOP

CE RoHS FC IC
Europe/US/Canada

Basic Parameters(Standard)

Size:	5000*10*10mm	CRI:	>90
Cutting Unit:	50mm	CCT:	2700K/3000K/4000K/6500K
Input Voltage:	DC24V	Lumen/M:	432lm/m
Input Current:	0.4A per meter	Lumen/W	45lm/w
Power:	9.6W/M	LED Qty:	120LEDs/m
Bend Diameter:	60mm	IP Class:	IP65

Optical Parameters(led strip inside)

P/N	Power/m	Qty(LED per meter)	Cutting Unit(mm)
2835-120-24V	9.6	120	50

Clips

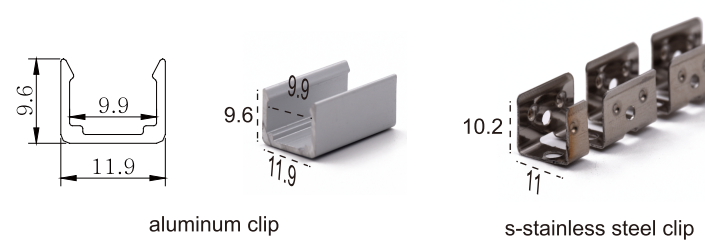

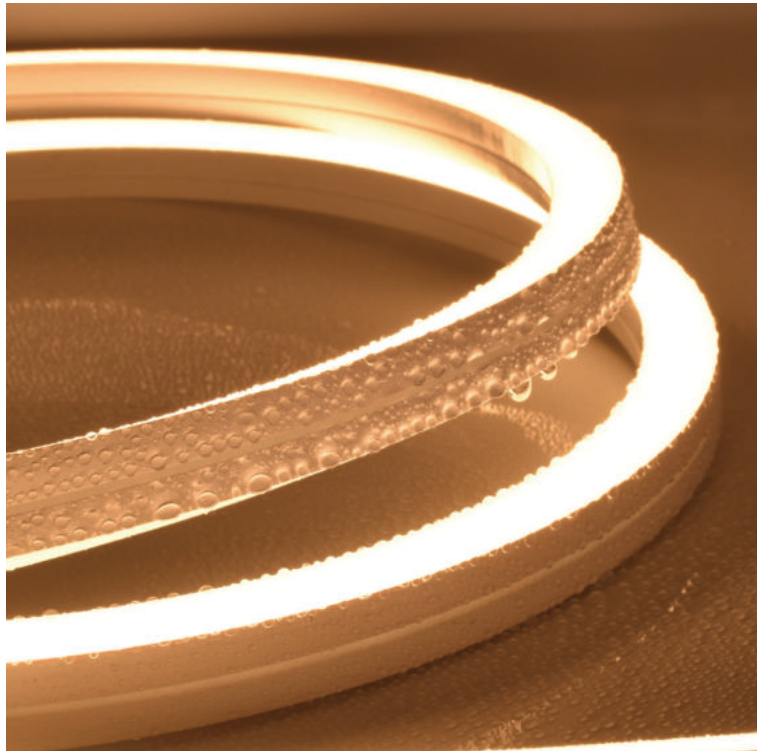

GU1010-SIDE

CE RoHS FC IC
Europe/US/Canada

Basic Parameters(Standard)

Size:	5000*10*10mm	CRI:	>90
Cutting Unit:	50mm	CCT:	1800K/2700K/3000K/4000K/6500K
Input Voltage:	DC24V	Lumen/M:	270m/m
Input Current:	0.4A per meter	Lumen/W	28lm/w
Power:	9.6W/M	LED Qty:	120LEDs/m
Bend Diameter:	60mm	IP Class:	IP65

Optical Parameters(led strip inside)

P/N	Power/m	Qty(LED per meter)	Cutting Unit(mm)
2835-120-24V	9.6	120	50

Clips

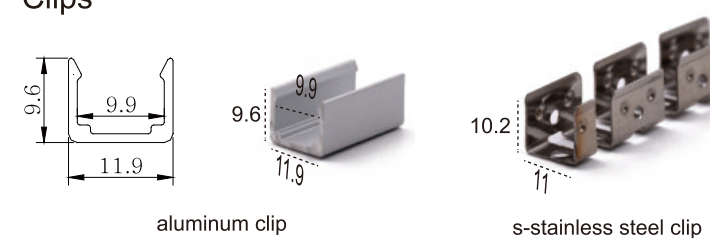

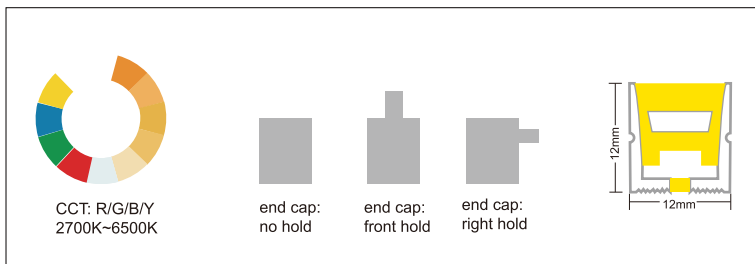

GU1212-TOP

CE RoHS FC IC
Europe/US/Canada

Basic Parameters(Standard)

Size:	5000*12*12mm	CRI:	>90
Cutting Unit:	50mm	CCT:	2700K/3000K/4000K/6000K
Input Voltage:	DC24V	Lumen/M:	670lm/m
Input Current:	0.4A per meter	Lumen/W	67lm/w
Power:	10W/M	LED Qty:	120LEDs/m
Bend Diameter:	60mm	IP Class:	IP67

P/N	Power/m	Qty(LED per meter)	Cutting Unit(mm)
2835-120-24V	10	120	50

Clips

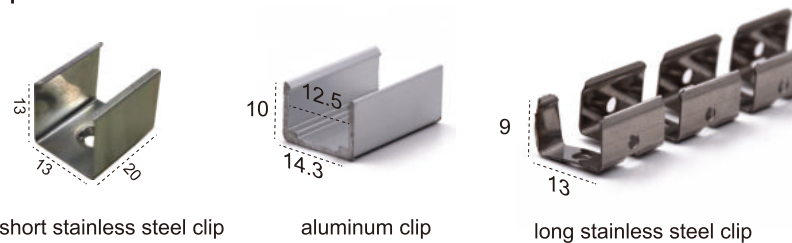

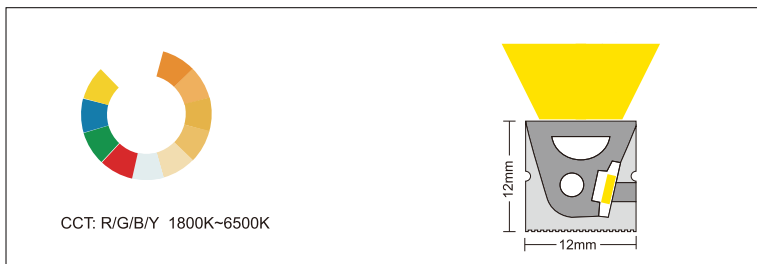
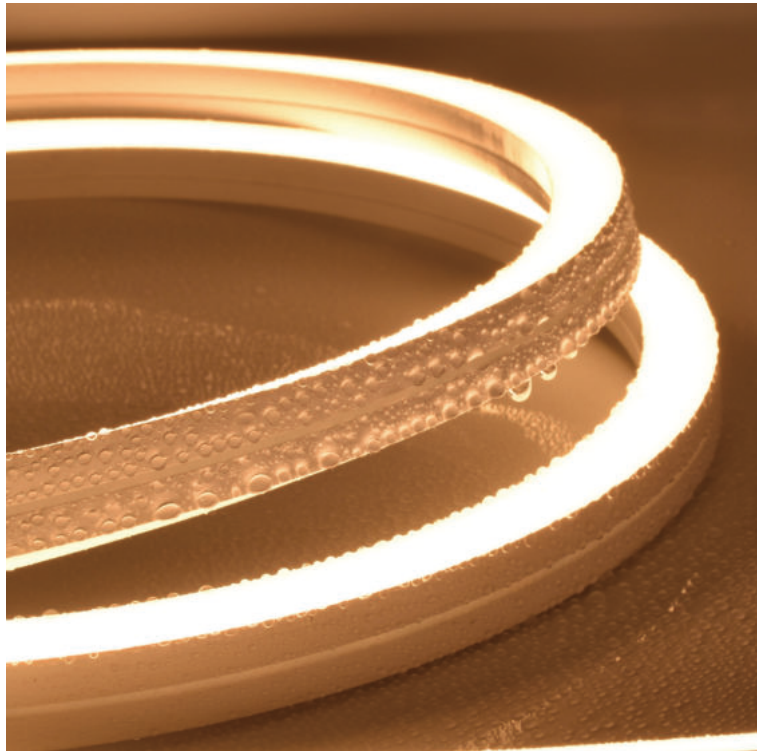

GU1212-SIDE

CE RoHS FC IC
Europe/US/Canada

Basic Parameters(Standard)

Size:	5000*12*12mm	CRI:	>80
Cutting Unit:	50mm/100mm	CCT:	1800K/2700K/3000K/4000K/6500K
Input Voltage:	DC12V/DC24V	Lumen/M:	650lm/m
Input Current:	0.8A/0.4A per meter	Lumen/W	67lm/w
Power:	9.6W/M	LED Qty:	120LEDs/m
Bend Diameter:	60mm	IP Class:	IP65

Optical Parameters(led strip inside)

P/N	Power/m	Qty(LED per meter)	Cutting Unit(mm)
2835-120-24V	9.6	120	50
2835-192-24V	9.6	192	31.25

Clips

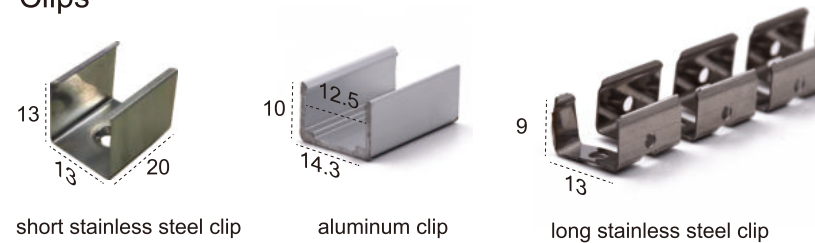

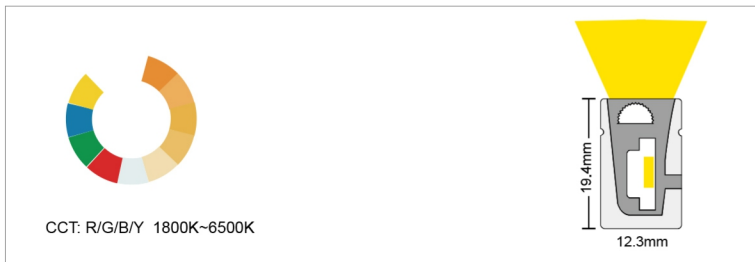

GU1220-SIDE

CE RoHS FC IC
Europe/US/Canada

Basic Parameters(Standard)

Size:	5000*12.3*19.4mm	CRI:	>80
Cutting Unit:	50mm/100mm	CCT:	1800K/2700K/3000K/4000K/6500K
Input Voltage:	DC12V/DC24V	Lumen/M:	650lm/m
Input Current:	0.8A/0.4A per meter	Lumen/W	67lm/w
Power:	9.6W/M	LED Qty:	120LEDs/m
Bend Diameter:	60mm	IP Class:	IP65

Optical Parameters(led strip inside)

P/N	Power/m	Qty(LED per meter)	Cutting Unit(mm)
2835-120-24V	9.6	120	50

Clips

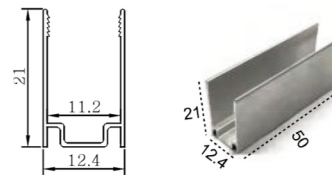

Aluminum clips



S-Stainless steel clips

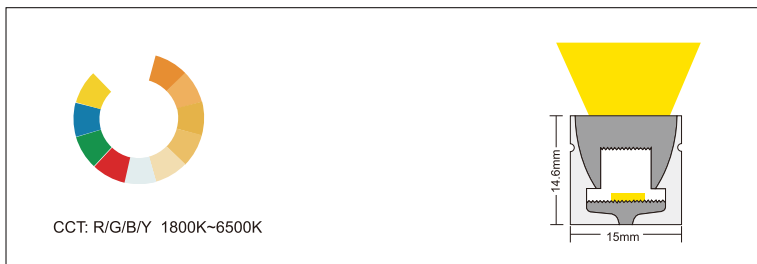

GU1515-TOP

CE RoHS FC IC
Europe/US/Canada

Basic Parameters(Standard)

Size:	5000*15*14.6mm	CRI:	>80
Cutting Unit:	50mm/100mm	CCT:	1800K/2700K/3000K/4000K/6500K
Input Voltage:	DC12V/DC24V	Lumen/M:	650lm/m
Input Current:	0.8A/0.4A per meter	Lumen/W	67lm/w
Power:	9.6W/M	LED Qty:	120LEDs/m
Bend Diameter:	30mm	IP Class:	IP65

P/N	Power/m	Qty(LED per meter)	Cutting Unit(mm)
2835-120-24V	9.6	120	50

Clips

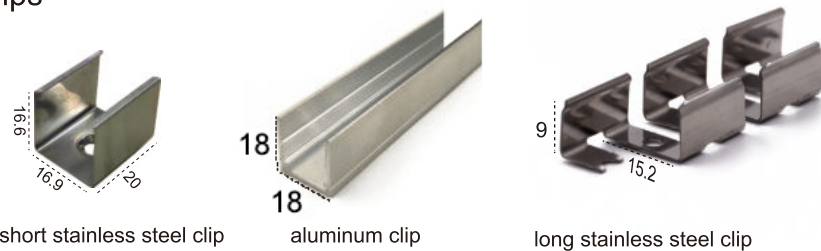

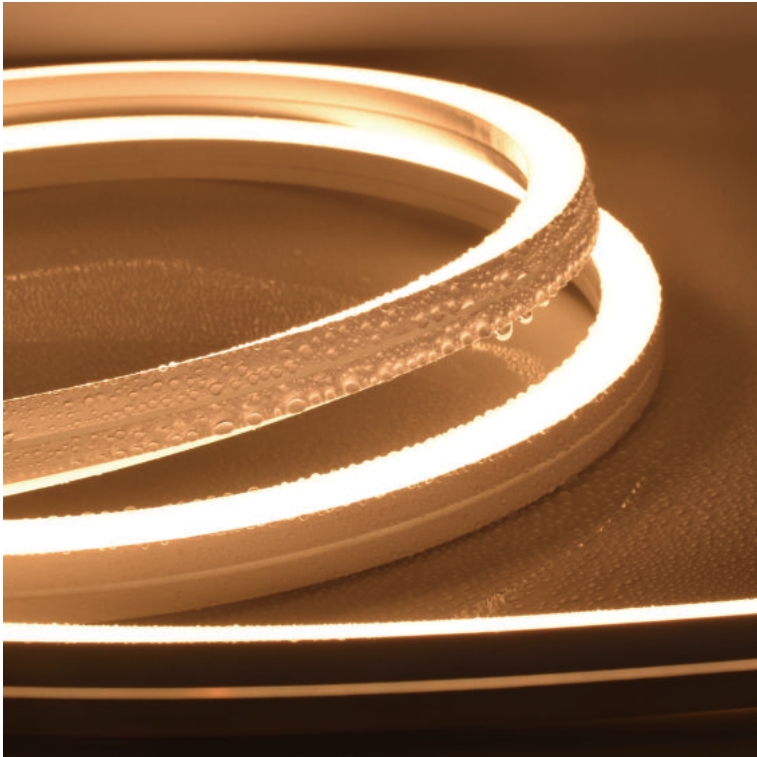

GU1515-SIDE

CE RoHS FC IC
Europe/US/Canada

Basic Parameters(Standard)

Size:	5000*15*15mm	CRI:	>90
Cutting Unit:	50mm/100mm	CCT:	1800K/2700K/3000K/4000K/6500K
Input Voltage:	DC12V/DC24V	Lumen/M:	1340lm/m
Input Current:	1.67A/0.83A per meter	Lumen/W	67lm/w
Power:	20W/M	LED Qty:	120LEDs/m
Bend Diameter:	60mm	IP Class:	IP67

Optical Parameters(led strip inside)

P/N	Power/m	Qty(LED per meter)	Cutting Unit(mm)
2835-120-24V	20	120	50

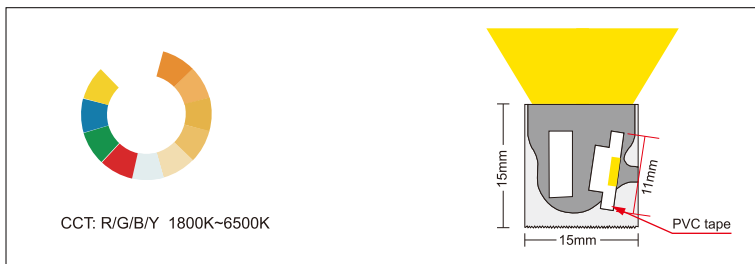

Clips

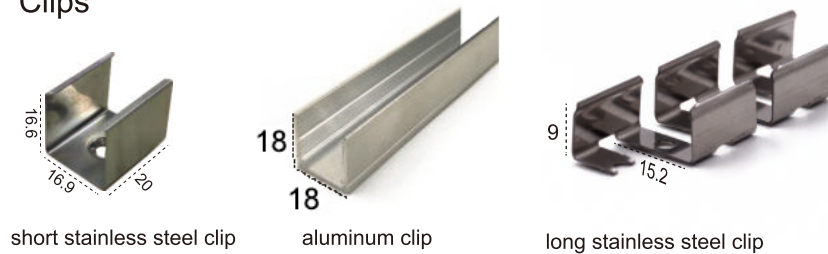



GU1617-SIDE

CE RoHS FC IC
Europe/US/Canada

Basic Parameters(Standard)

Size:	5000*16*17mm	CRI:	>90
Cutting Unit:	50mm/100mm	CCT:	1800K/2700K/3000K/4000K/6500K
Input Voltage:	DC12V/DC24V	Lumen/M:	1340lm/m
Input Current:	1.67A/0.83A per meter	Lumen/W	67lm/w
Power:	20W/M	LED Qty:	120LEDs/m
Bend Diameter:	60mm	IP Class:	IP67

Optical Parameters(led strip inside)

P/N	Power/m	Qty(LED per meter)	Cutting Unit(mm)
2835-120-24V	20	120	50

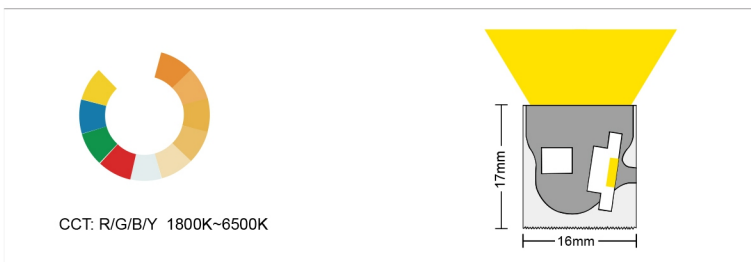

Clips

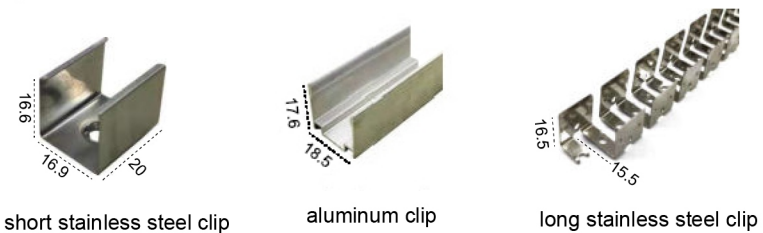



GU2014-TOP

wide angle/three lighting surface



Basic Parameters(Standard)

Size:	20*14mm	CRI:	>80
Cutting Unit:	50mm/100mm	CCT:	2700K/3000K/4000K/6500K
Input Voltage:	DC24V	Lumen/M:	650lm/m
Input Current:	0.4A per meter	Lumen/W	67lm/w
Power:	9.6W/M	LED Qty:	120LEDs/m
Bend Diameter:	60mm	IP Class:	IP67

Optical Parameters(led strip inside)

P/N	Power/m	Qty(LED per meter)	Cutting Unit(mm)
2835-120-24V	9.6	120	50

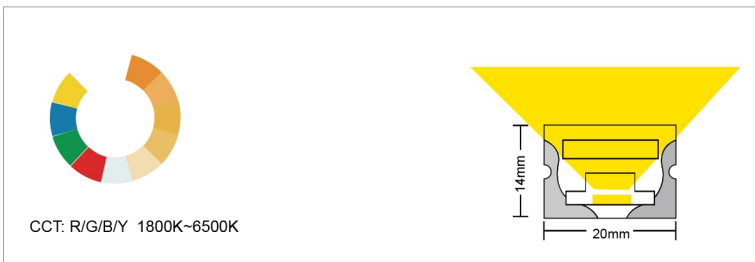

Accessory

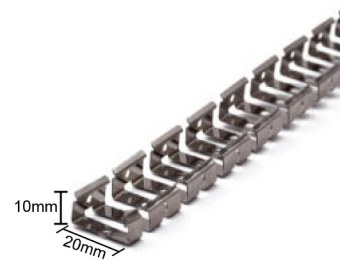

steel clip

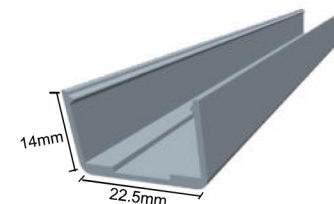

aluminous clip



GUD270-ROUND

CE RoHS FC IC
Europe/US/Canada



Basic Parameters(Standard)

Size:	D13/15/19/22mm	CRI:	>80
Cutting Unit:	50mm	CCT:	1800K/2700K/3000K/4000K/6500K
Input Voltage:	DC24V	Lumen/M:	1000lm/m
Input Current:	0.625A per meter	Lumen/W	67lm/w
Power:	15W/M	LED Qty:	120LEDs/m
Bend Diameter:	60mm	IP Class:	IP65

Optical Parameters(led strip inside)

P/N	Cutting Unit(mm)
2835-120-24V	50

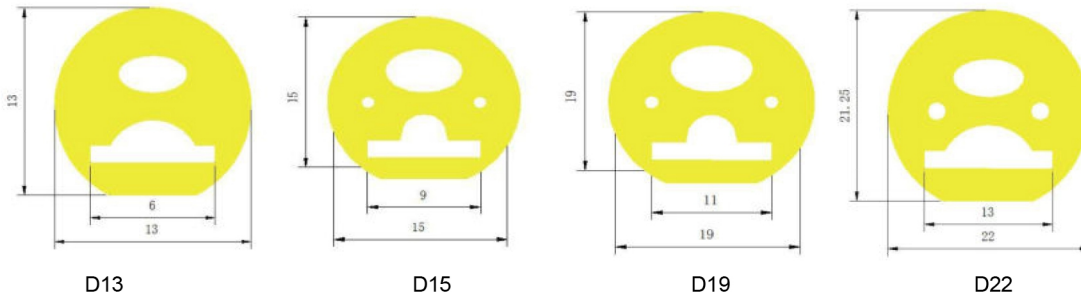



GUD360-ROUND

CE RoHS FC IC
Europe/US/Canada



Basic Parameters(Standard)

Size:	D15/16/22/28/38mm	CRI:	>80
Cutting Unit:	50mm	CCT:	1800K/2700K/3000K/4000K/6500K
Input Voltage:	DC24V	Lumen/M:	1000lm/m
Input Current:	0.625A per meter	Lumen/W	67lm/w
Power:	15W/M	LED Qty:	120LEDs/m
Bend Diameter:	60mm	IP Class:	IP65

Optical Parameters(led strip inside)

P/N	Cutting Unit(mm)
2835-120-24V	50

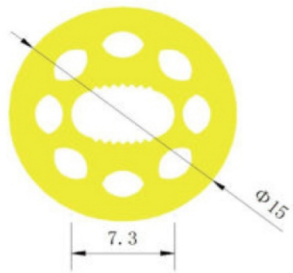

C15

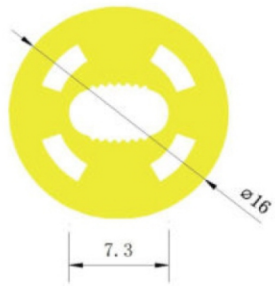

C16

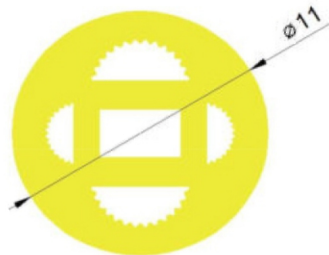

C22

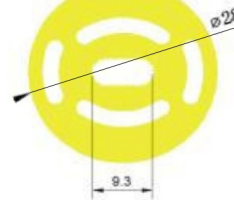

C28

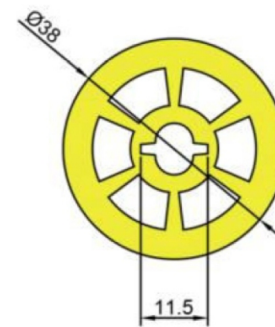

C38

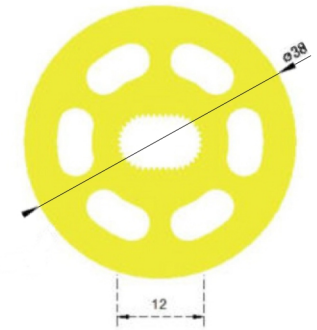

C38



GUC1616

CE RoHS FC IC
Europe/US/Canada

Basic Parameters(Standard)

Size:	5000*16*16mm	CRI:	>80
Cutting Unit:	50mm	CCT:	1800K/2700K/3000K/4000K/6500K
Input Voltage:	DC12V/DC24V	Lumen/M:	650lm/m
Input Current:	0.8A/0.4A per meter	Lumen/W	67lm/w
Power:	9.6W/M	LED Qty:	120LEDs/m
		IP Class:	IP65

Optical Parameters(led strip inside)

P/N	Cutting Unit(mm)
2835-120-24V	50

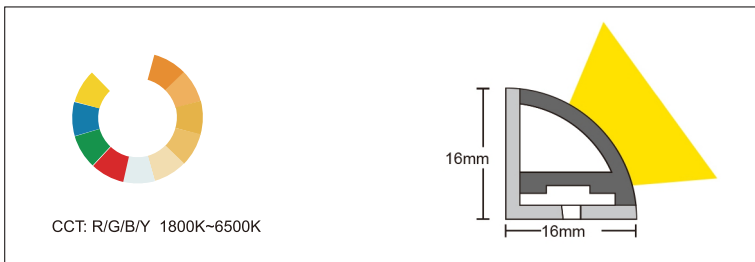



GU1307R

CE RoHS FC IC
Europe/US/Canada

Basic Parameters(Standard)

Size:	5000*13*7mm	CRI:	>80
Cutting Unit:	50mm	CCT:	2700K/3000K/4000K/6500K
Input Voltage:	DC24V	Lumen/M:	600lm/m
Input Current:	0.4A/m	Lumen/W	63lm/w
Power:	9.6W/M	LED Qty:	120LEDs/m
Bend Diameter:	60mm	IP Class:	IP65

Optical Parameters(led strip inside)

P/N	Power/m	Qty(LED per meter)	Cutting Unit(mm)
2835-120-24V	9.6	120	50
2835-192-24V	15	192	31.2

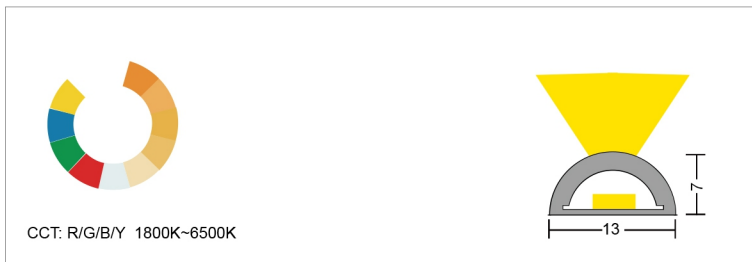

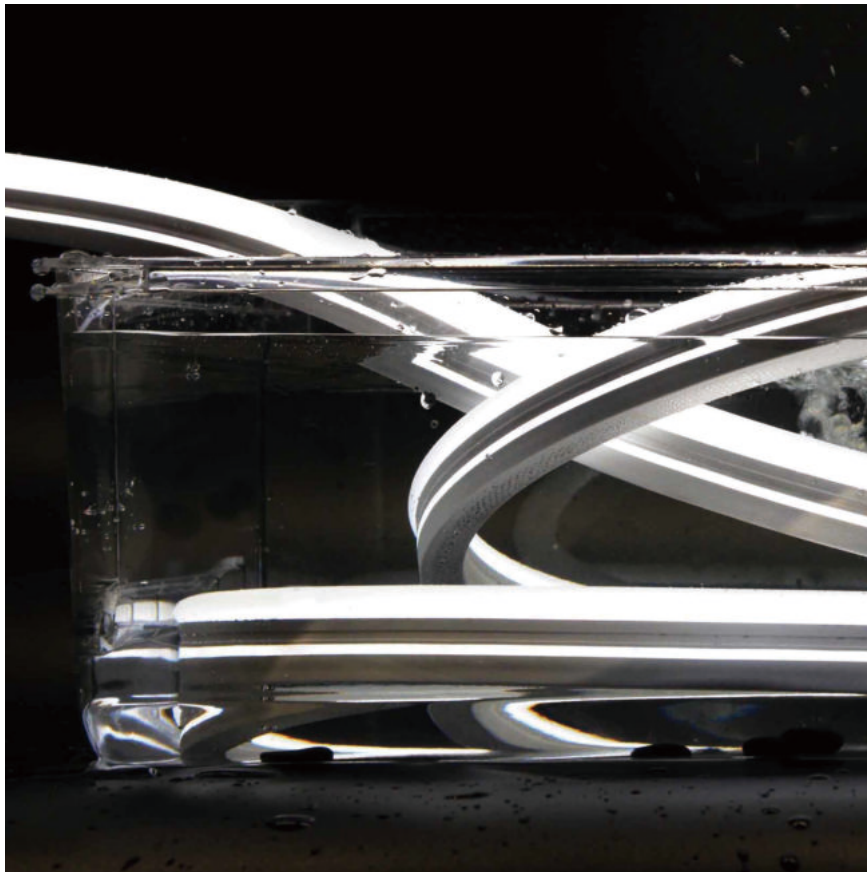

GU1225-SIDE

CE RoHS FC IC
Europe/US/Canada

Basic Parameters(Standard)

Size:	5000*12*25mm	CRI:	>80
Cutting Unit:	50mm/100mm	CCT:	1800K/2700K/3000K/4000K/6500K
Input Voltage:	DC12V/DC24V	Lumen/M:	650lm/m
Input Current:	0.8A/0.4A per meter	Lumen/W	67lm/w
Power:	9.6W/M	LED Qty:	120LEDs/m
Bend Diameter:	60mm	IP Class:	IP68

Optical Parameters(led strip inside)

P/N	Power/m	Qty(LED per meter)	Cutting Unit(mm)
2835-120-24V	9.6	120	50

Clips

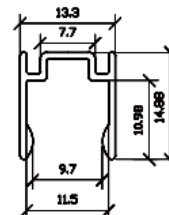

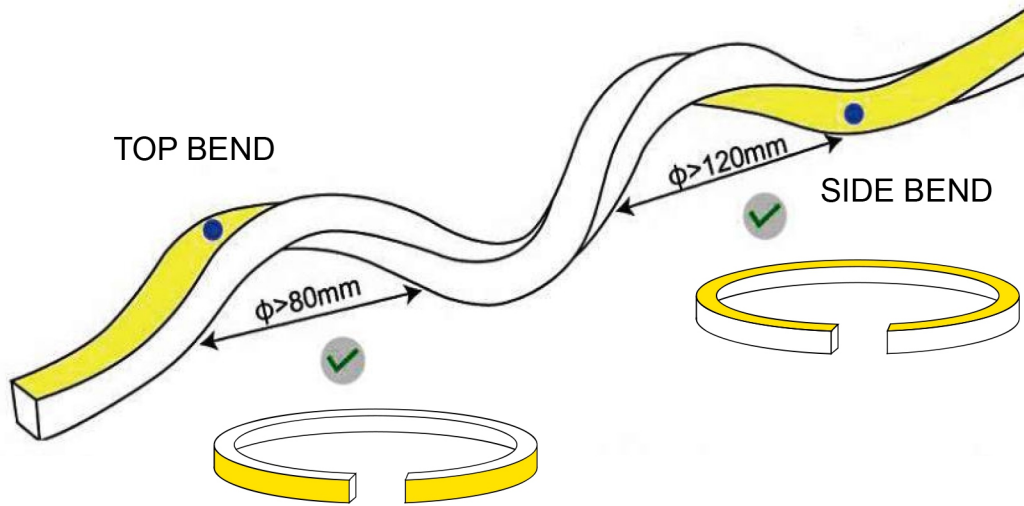

GU3D1616

CE RoHS FC IC
Europe/US/Canada

Basic Parameters(Standard)

Size:	5000*16*16mm	CRI:	>90
Cutting Unit:	50mm	CCT:	1800K/2700K/3000K/4000K/6500K
Input Voltage:	DC24V	Lumen/M:	670lm/m
Input Current:	0.4A/m	Lumen/W	67lm/w
Power:	10W/M	LED Qty:	120LEDs/m
Bend Diameter:	top bend>80,side bend >120	IP Class:	IP67

Optical Parameters(led strip inside)

P/N	Power/m	Qty(LED per meter)	Cutting Unit(mm)
2835-120-24V	10	120	50

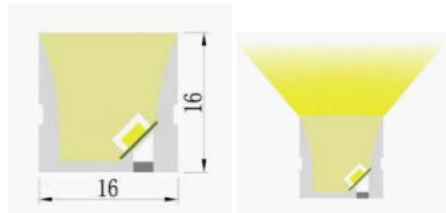
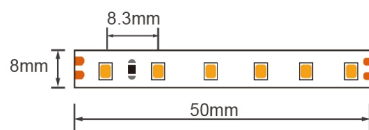

Clips

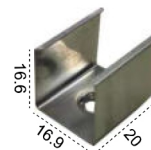

short stainless steel clip

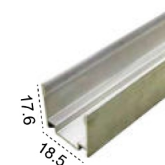

aluminum clip



long stainless steel clip

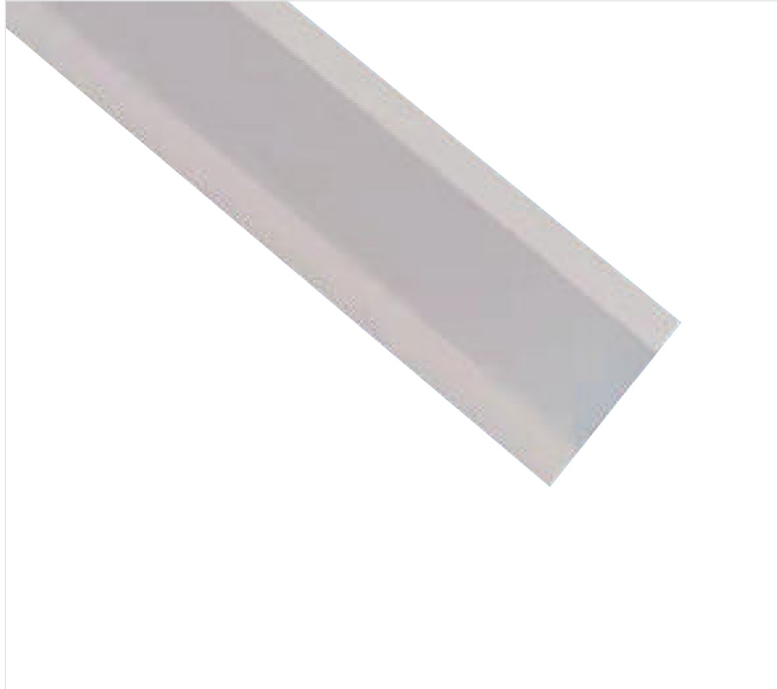

GU-N1010

CE RoHS FC IC
Europe/US/Canada

Basic Parameters

PCB Width(mm): 5/6mm
Weight(g/m): 82g
Section Size(mm): 15x10mm

Lighting Source

P/N	Power/m	Qty(LED per meter)	Cutting Unit(mm)	PCB
2835-120-24V	9.6	120	50	5mm
COB-384-5MM	10	120	41.66	5mm

Application

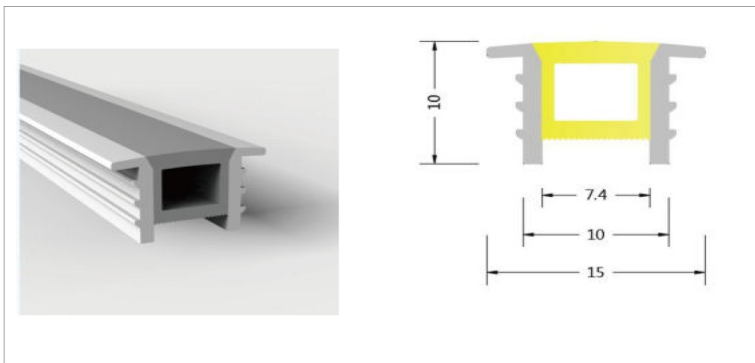
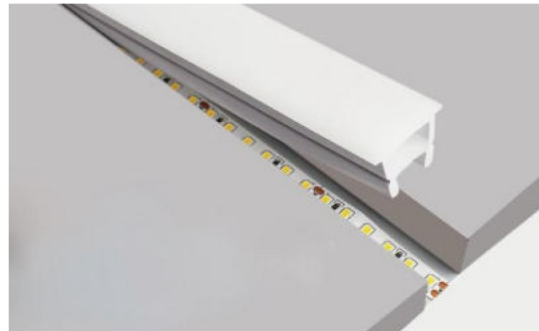

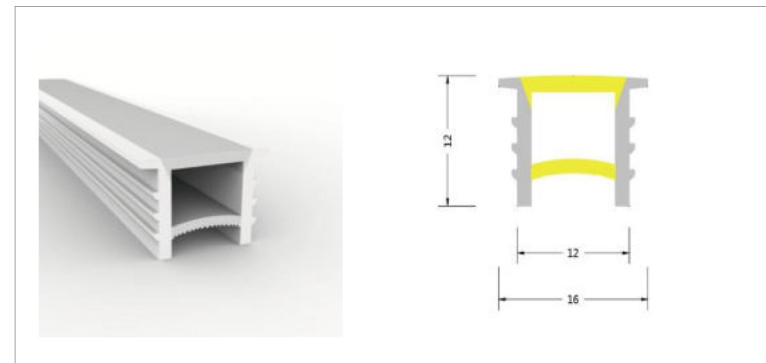
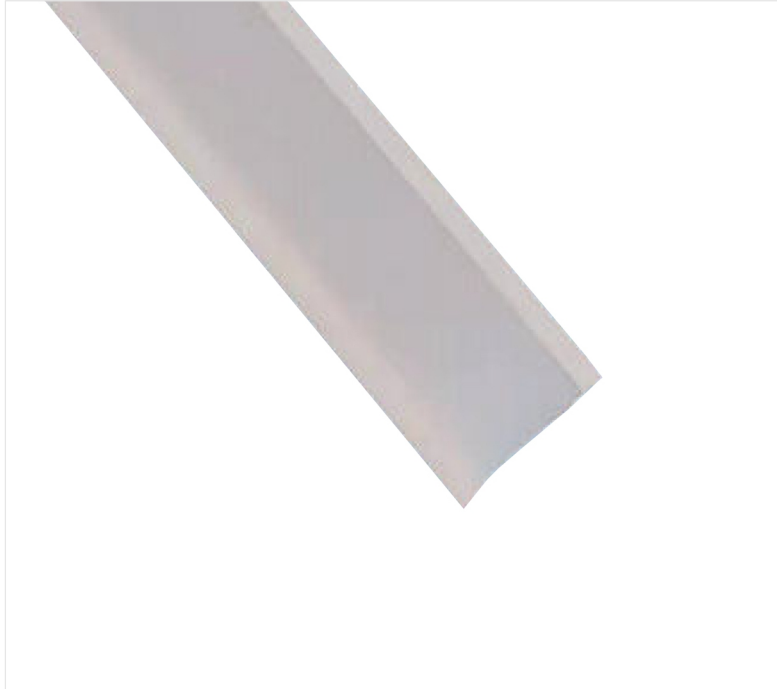

GU-N1212

CE RoHS FC IC
Europe/US/Canada

Basic Parameters

PCB Width(mm): 8mm
Weight(g/m): 79g
Section Size(mm): 16x12mm

Lighting Source

P/N	Power/m	Qty(LED per meter)	Cutting Unit(mm)	PCB
2835-120-24V	12	120	50	8mm

Application





GU-N1616-YT

CE RoHS FC IC
Europe/US/Canada

Basic Parameters

PCB Width(mm): 8/10mm
Weight(g/m): 179g
Section Size(mm): 16x16mm

Lighting Source

P/N	Power/m	Qty(LED per meter)	Cutting Unit(mm)	PCB
2835-120-24V	12	120	50	8/10mm

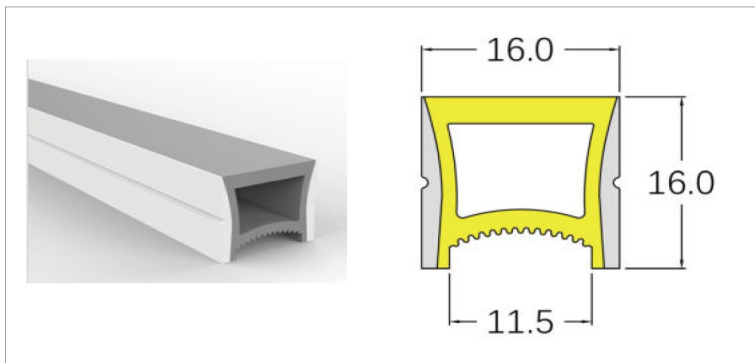

Application

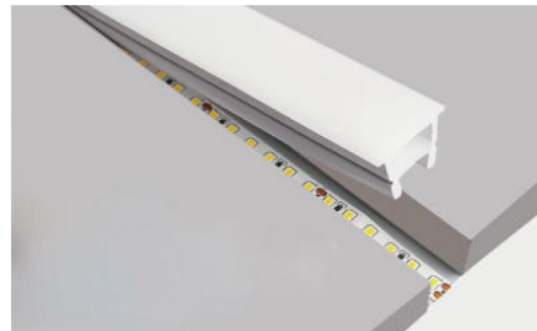



GU-N1616

CE RoHS FC IC
Europe/US/Canada

Basic Parameters

PCB Width(mm): 12mm
Weight(g/m): 180g
Section Size(mm): 20x16mm

Lighting Source

P/N	Power/m	Qty(LED per meter)	Cutting Unit(mm)
2835-120-24	12	120	50

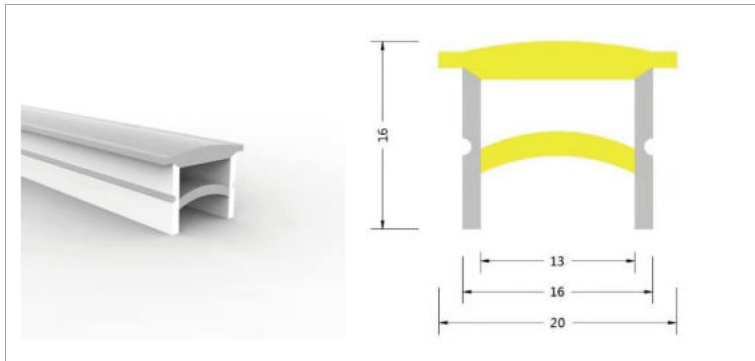

Application

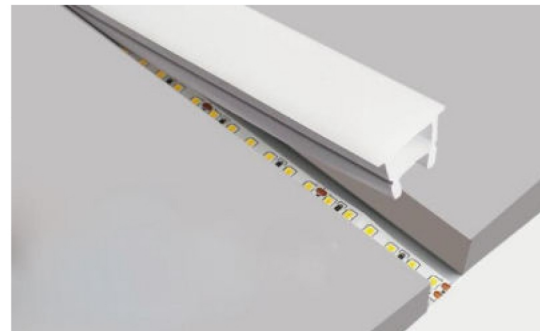



GU-N2010

CE RoHS FC IC
Europe/US/Canada

Basic Parameters

PCB Width(mm): 10/12/14mm
Weight(g/m): 120g
Section Size(mm): 25x10mm

Lighting Source

P/N	Power/m	Qty(LED per meter)	Cutting Unit(mm)	PCB
2835-240-24V	18	240	25	15

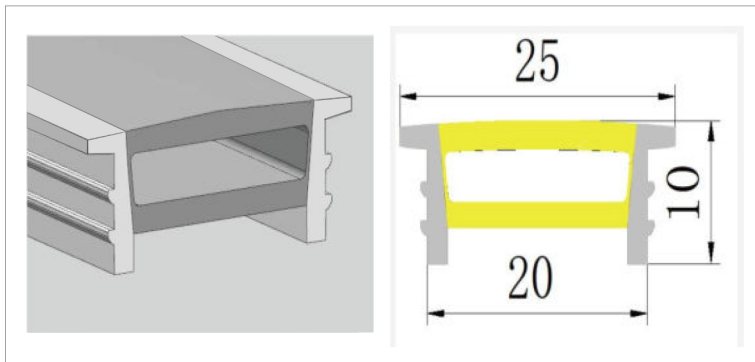

Application

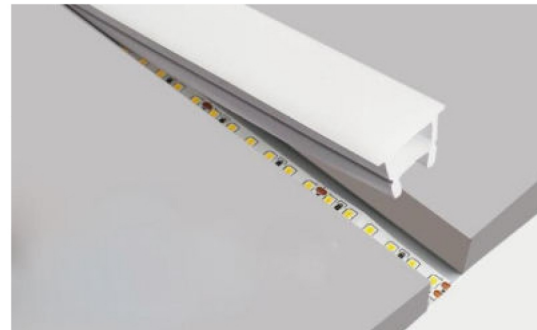

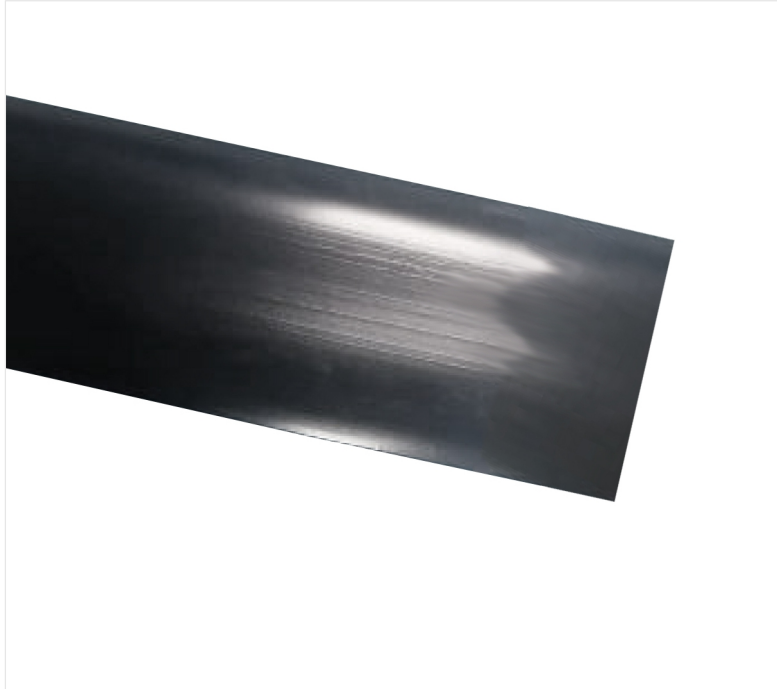

GU-N2010-B

CE RoHS FC IC
Europe/US/Canada

Basic Parameters

PCB Width(mm): 10/12/14mm
Weight(g/m): 120g
Section Size(mm): 25x10mm

Lighting Source

P/N	Power/m	Qty(LED per meter)	Cutting Unit(mm)	PCB
2835-240-24V	18	240	25	15

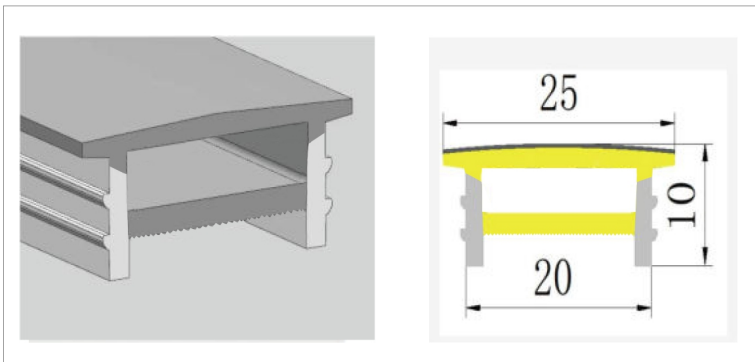

Application

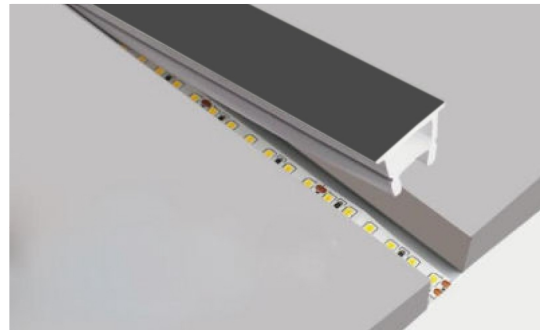



GU-N2010-C

CE RoHS FC IC
Europe/US/Canada

Basic Parameters

PCB Width(mm): 10/12/14mm
Weight(g/m): 120g
Section Size(mm): 25x10mm

Lighting Source

P/N	Power/m	Qty(LED per meter)	Cutting Unit(mm)	PCB
2835-240-24V	18	240	25	15

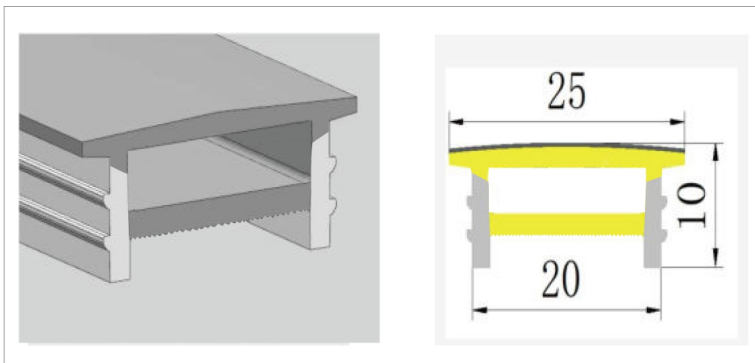

Application

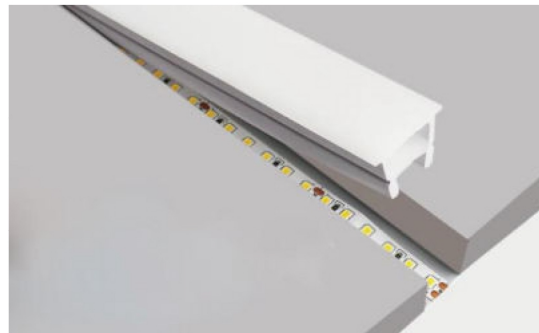



GU-N2020-YT

CE RoHS FC IC
Europe/US/Canada

Basic Parameters

PCB Width(mm): 12mm
Weight(g/m): 250g
Section Size(mm): 20x20mm

Lighting Source

P/N	Power/m	Qty(LED per meter)	Cutting Unit(mm)	PCB
2835-120-24V	18	120	50	10

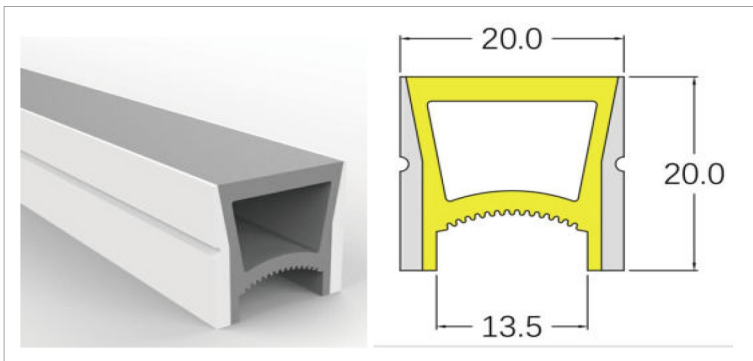

Application

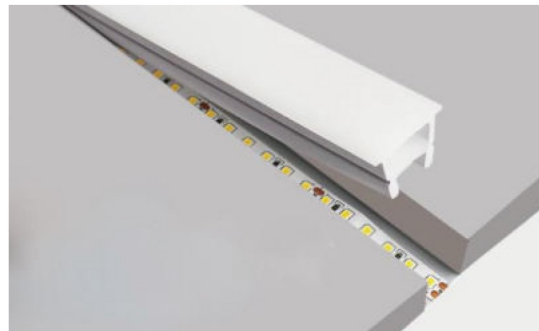



GU-N2020-B

CE RoHS FC IC
Europe/US/Canada

Basic Parameters

PCB Width(mm): 10/12/14mm
Weight(g/m): 216g
Section Size(mm): 27x20mm

Lighting Source

P/N	Power/m	Qty(LED per meter)	Cutting Unit(mm)	PCB
2835-240-24V	18	240	25	15
2835-120-24V	18	120	50	10

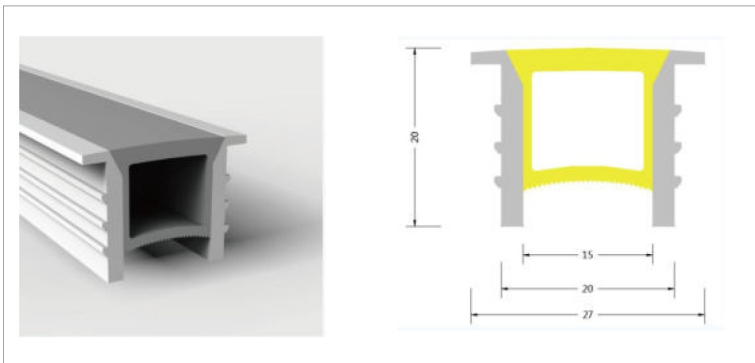

Application

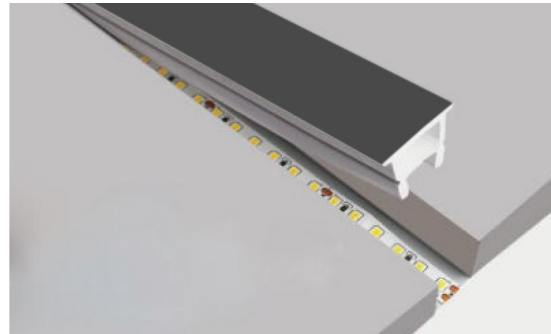

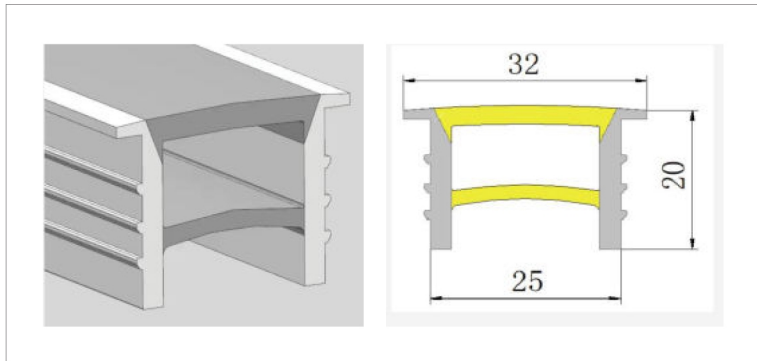

GU-N2520

CE RoHS FC IC
Europe/US/Canada

Basic Parameters

PCB Width(mm): 20mm
Weight(g/m): 276g
Section Size(mm): 27x20mm

Lighting Source

P/N	Power/m	Qty(LED per meter)	Cutting Unit(mm)	PCB
2835-120-24V	9.6	120	50	8
2835-240-24V	18	240	25	15

Application





GU-N3020

CE RoHS FC IC
Europe/US/Canada

Basic Parameters

PCB Width(mm): 21mm
Weight(g/m): 345g
Section Size(mm): 36x20mm

Lighting Source

P/N	Power/m	Qty(LED per meter)	Cutting Unit(mm)	PCB
2835-120-24V	9.6	120	50	8
2835-240-24V	18	240	25	15

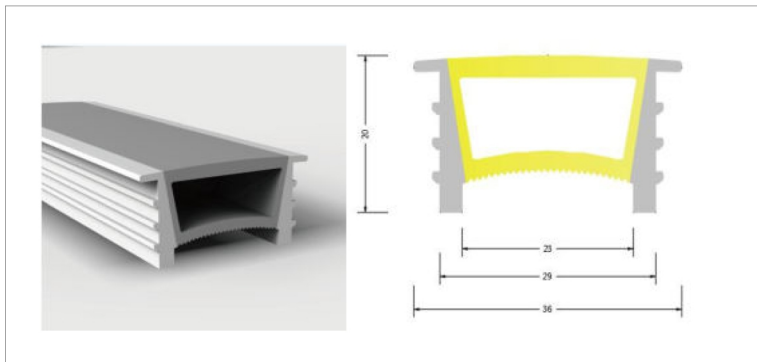

Application

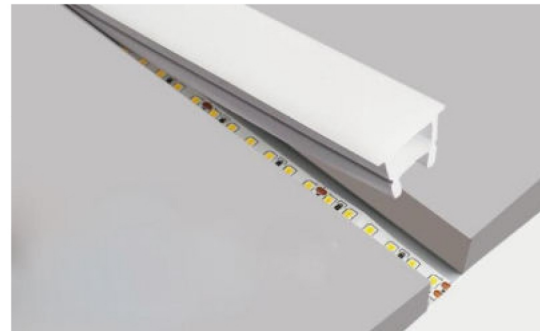

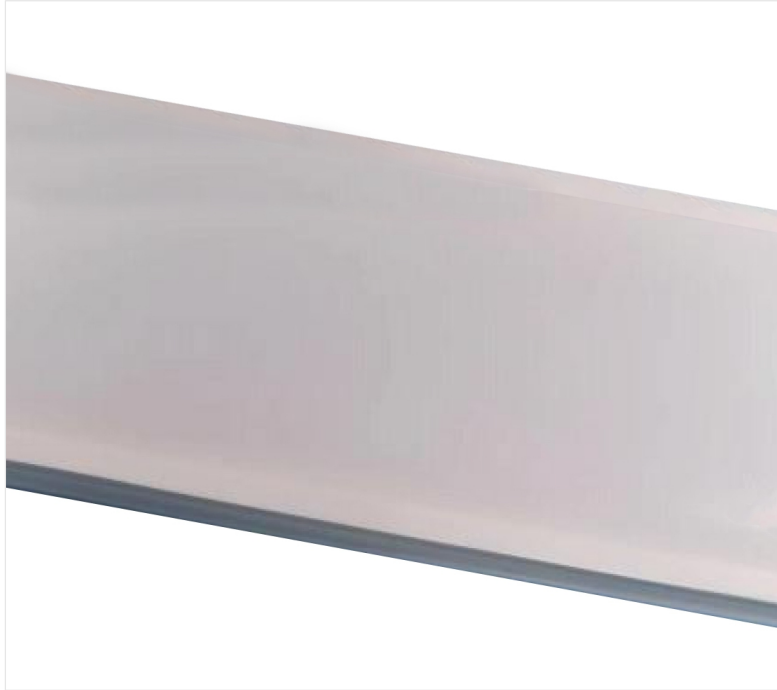

GU-N4020

CE RoHS FC IC
Europe/US/Canada

Basic Parameters

PCB Width(mm): 34mm
Weight(g/m): 370g
Section Size(mm): 48x20mm

Lighting Source

P/N	Power/m	Qty(LED per meter)	Cutting Unit(mm)	PCB
2835-120-24V	9.6	120	50	8

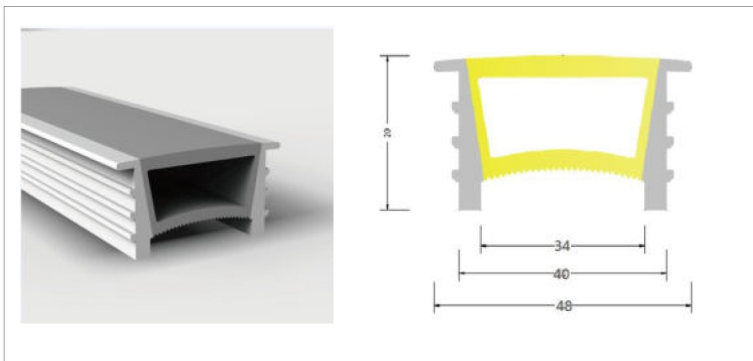

Application

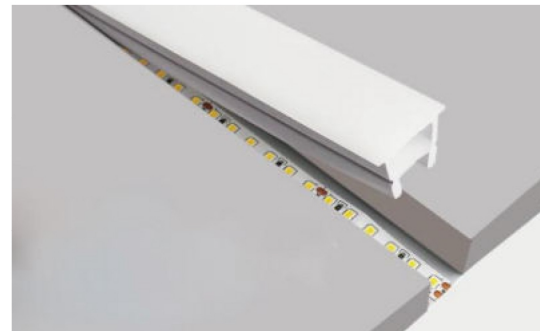

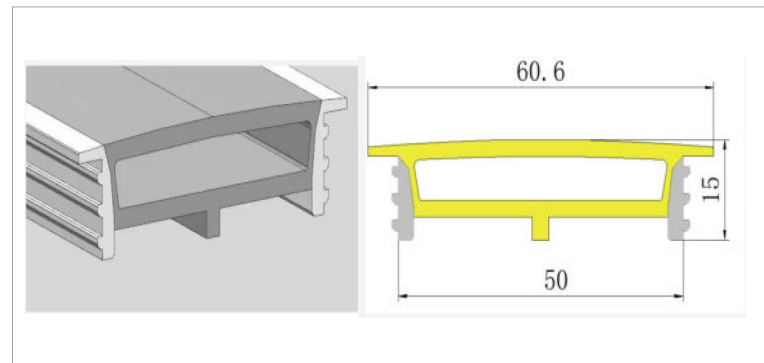
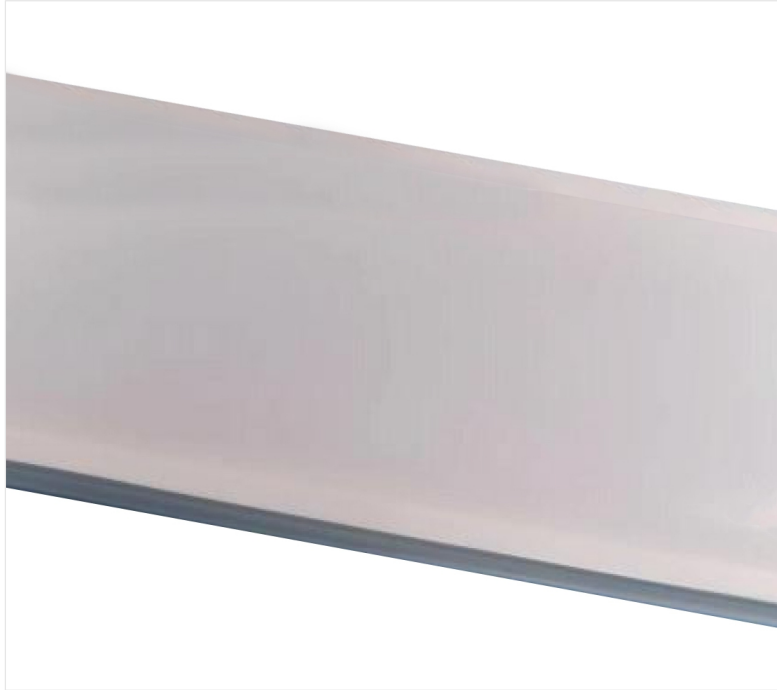

GU-N5015

CE RoHS FC IC
Europe/US/Canada

Basic Parameters

PCB Width(mm): 22/20/14mm
Weight(g/m): 370g
Section Size(mm): 60.6x15mm

Lighting Source

P/N	Power/m	Qty(LED per meter)	Cutting Unit(mm)	PCB
2835-120-24V	9.6	120	50	8
2835-240-24V	18	240	25	15

Application

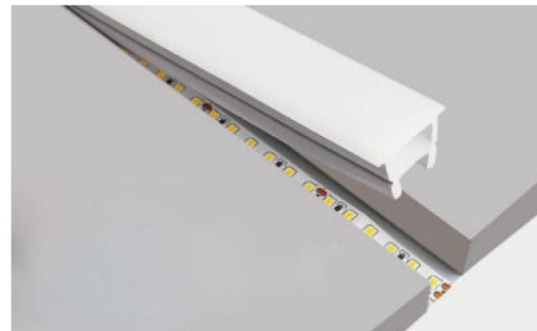



Ad tube-8

CE RoHS FC IC
Europe/US/Canada

Basic Parameters

PCB Width(mm): 8mm
Weight(g/m): 82g
Section Size(mm): 8x9.8mm

Lighting Source

P/N	Power/m	Qty(LED per meter)	Cutting Unit(mm)	PCB
2835-120-24V-S	9.6	120	50	6mm
2835-120-12V-S	9.6	120	25	6mm
2835-120-24V 1led/section	9.6	120	8.3	8mm

Application

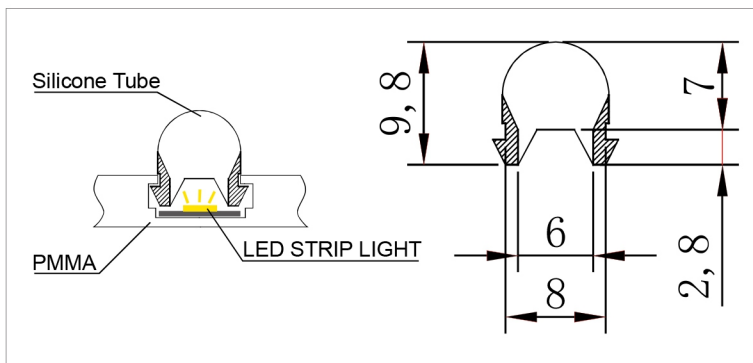



Ad tube-8

CE RoHS FC IC
Europe/US/Canada

Basic Parameters

PCB Width(mm): 8mm
Weight(g/m): 100g
Section Size(mm): 6x12mm

Lighting Source

P/N	Power/m	Qty(LED per meter)	Cutting Unit(mm)	PCB
2835-120-24V	8	120	50	8mm





FOB384-W12/24-5MM

- Ultra-narrow,5mm width
- Lumen output up to 1000 lm/m
- Low glare
- 3-Step MacAdam's ellipse, single binning
- Superior color consistency and dimming performance

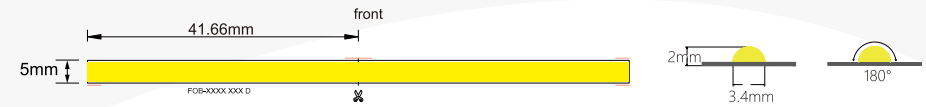

12/24V

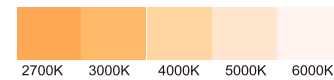

CE RoHS
FC IC

Power Consumption	10W/M	
Lumen flux	1000lm/m	
Input Voltage	DC24V	DC12V
Cutting Size(mm)	41.66mm	41.66mm
CRI/Ra	90	
LED Quantity/m	384LEDs/m	
Size(W*L)	5mm*5000mm	
CCT(K)	2700K/3000K/4000K 6000K	
Bend diameter	60mm	
Beam Angle	140°	
Lumen efficacy	100lm/W	
IP Class	IP20	
	IP65	silicone tube

LUMINOUS INTENSITY DISTRIBUTION

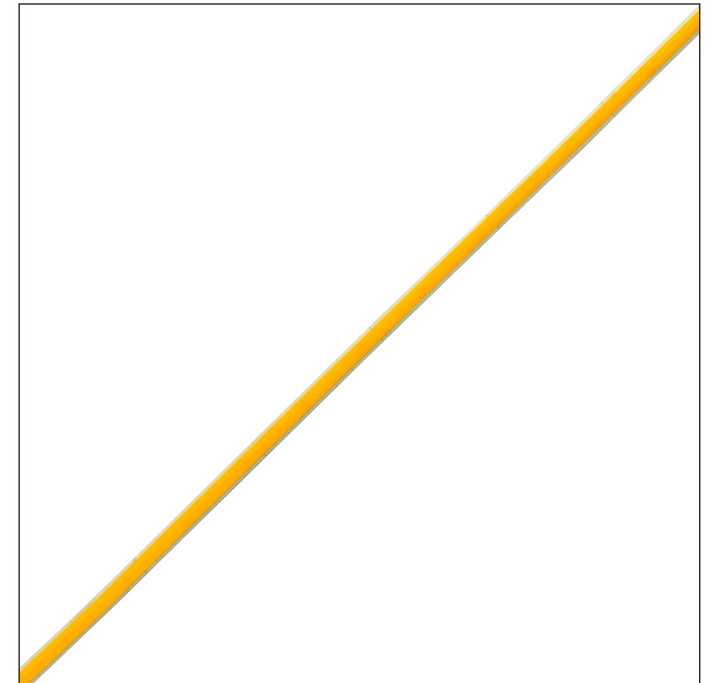
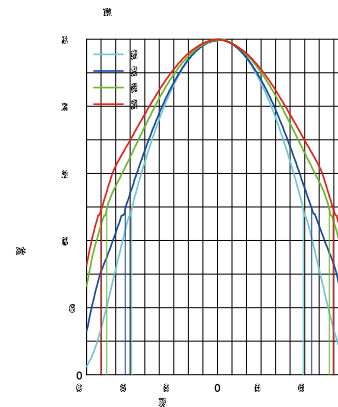
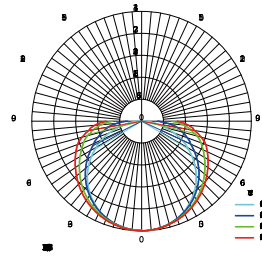



FOB384-W12/24-8MM

- Efficiency up to 100 lm/w
- Lumen output up to 1000 lm/m
- Low glare,
- 3-Step MacAdam's ellipse, single binning
- Superior color consistency and dimming performance

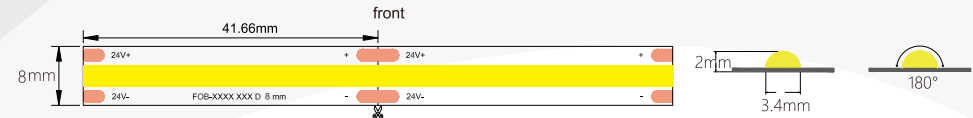

12V/24V

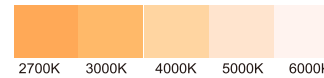

Power Consumption	10W/M	
Lumen flux	1000lm/m	
Input Voltage	DC24V	DC12V
Cutting Size(mm)	41.66mm	41.66mm
CRI/Ra	90	
LED Quantity/m	384LEDs/m	
Size(W*L)	8mm*5000mm	
CCT(K)	2700K/3000K/4000K 6000K	
Bend diameter	60mm	
Beam Angle	140°	
Lumen efficacy	100lm/W	
IP Class	IP20	IP65 silicone tube

LUMINOUS INTENSITY DISTRIBUTION

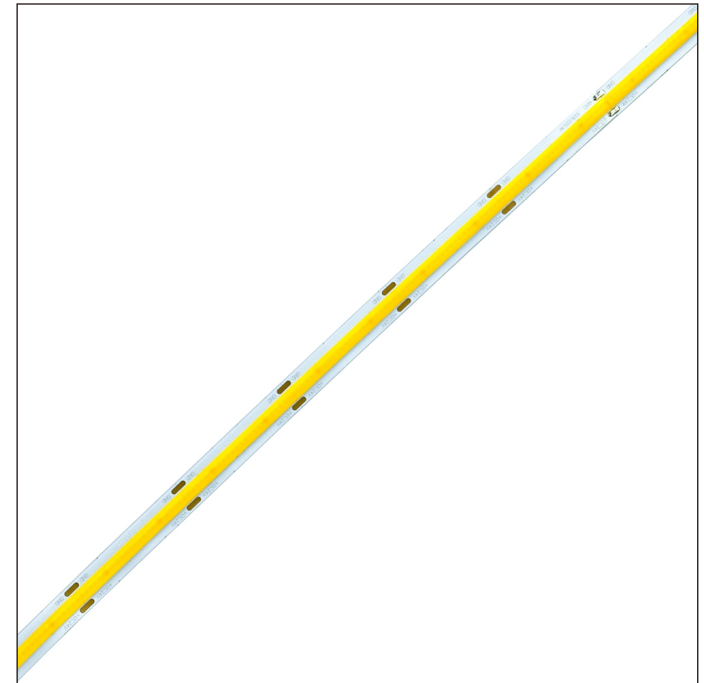
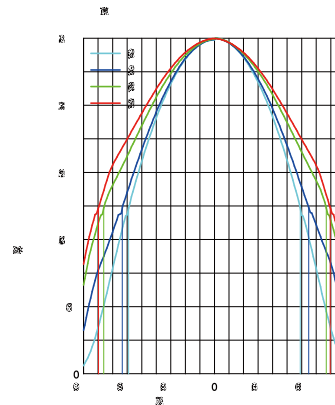
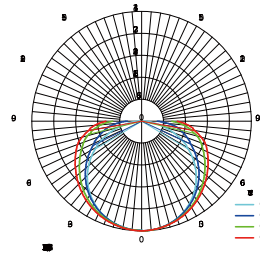



FOB480-W12/24-8MM

- Efficiency up to 100 lm/w
- Lumen output up to 1100 lm/m
- Low glare,
- 3-Step MacAdam's ellipse, single binning
- Superior color consistency and dimming performance

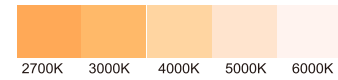
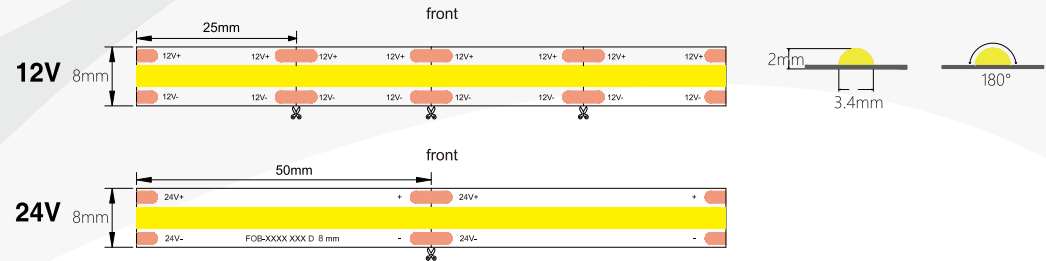

Power Consumption	11W/M	
Lumen flux	1100lm/m	
Input Voltage	DC24V	DC12V
Cutting Size(mm)	50mm	25mm
CRI/Ra	90	
LED Quantity/m	480LEDs/m	
Size(W*L)	8mm*5000mm	
CCT(K)	2700K/3000K/4000K 6000K	
Bend diameter	60mm	
Beam Angle	140°	
Lumen efficacy	100lm/W	
IP Class	IP20	
	IP65	silicone tube

LUMINOUS INTENSITY DISTRIBUTION

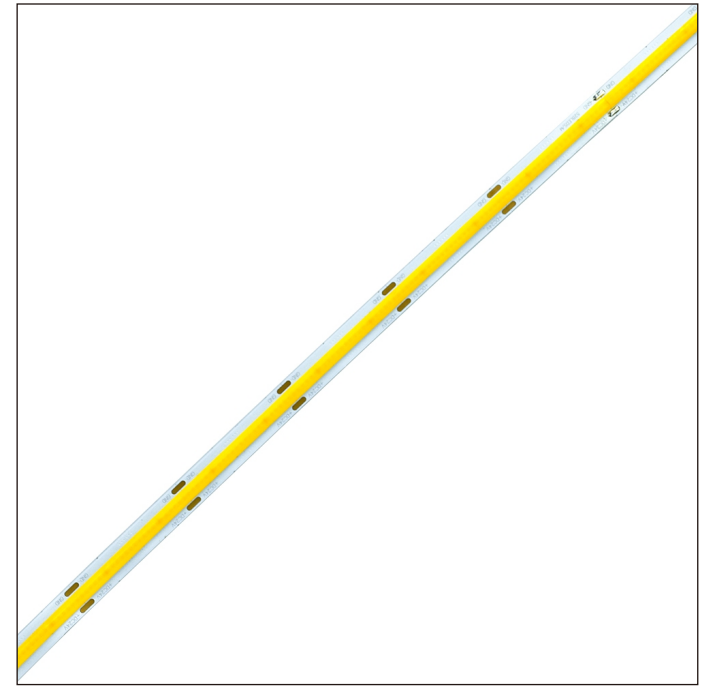
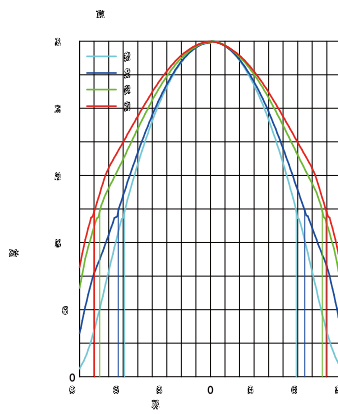
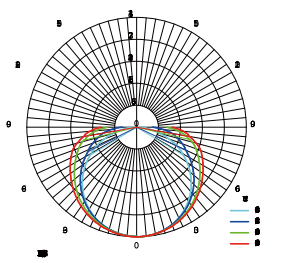



FOB528-W12/24-10MM

- Efficiency up to 100 lm/w
- Lumen output up to 1400 lm/m
- Low glare, no light-spot
- 3-Step MacAdam's ellipse, single binning
- Superior color consistency and dimming performance



CE RoHS
FC IC

Power Consumption	14W/M	
Lumen flux	1400lm/m	
Input Voltage	DC24V	DC12V
Cutting Size(mm)	45.45mm	45.45mm
CRI/Ra	90	
LED Quantity/m	528LEDs/m	
Size(W*L)	10mm*5000mm	
CCT(K)	2700K/3000K/4000K 6000K	
Bend diameter	60mm	
Beam Angle	140°	
Lumen efficacy	100lm/W	
IP Class	IP20	
	IP65	silicone tube

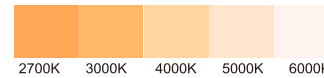
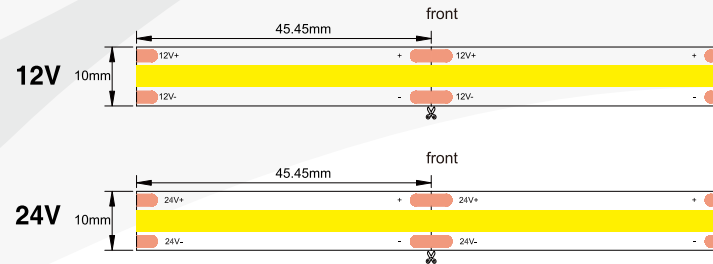

LUMINOUS INTENSITY DISTRIBUTION

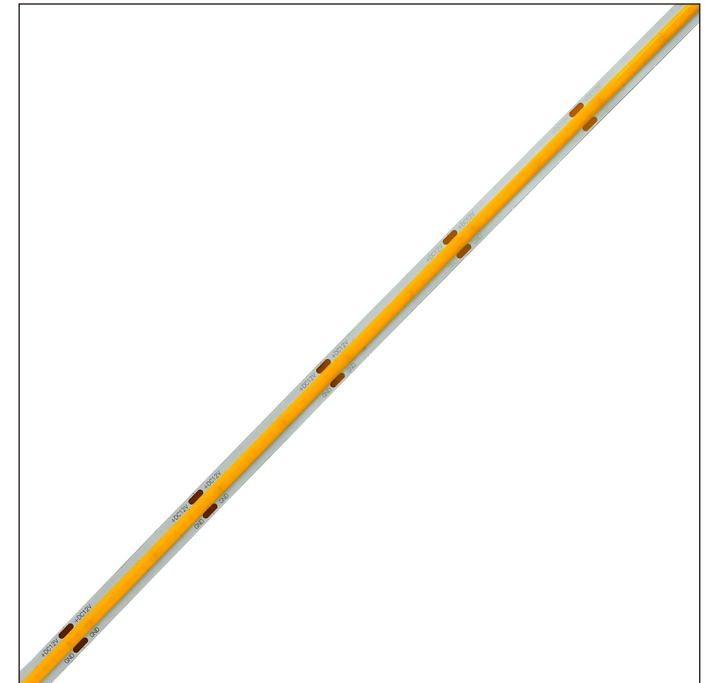
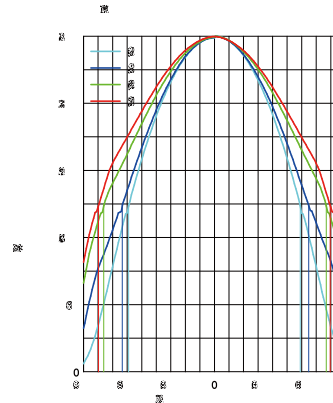
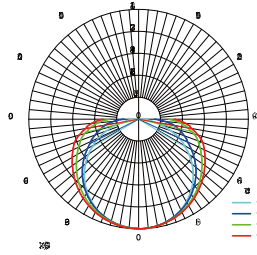



FOB608-CCT-W12/24

- Efficiency up to 100 lm/w
- CCT toning, color temperature adjustable
- Low glare
- 3-Step MacAdam's ellipse, single binning
- Superior color consistency and dimming performance



CE RoHS
FC IC

Power Consumption	14W/M(7W+7W)	
Lumen flux	700+700lm/m	
Input Voltage	DC24V	DC12V
Cutting Size(mm)	26.31mm	26.31mm
CRI/Ra	90	
LED Quantity/m	608LEDs/m	
Size(W*L)	8mm*5000mm	
CCT(K)	2700K~6500K	
Bend diameter	60mm	
Beam Angle	140°	
Lumen efficacy	100lm/W	
IP Class	IP20	
	IP65	silicone tube

12V

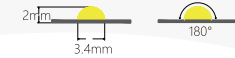
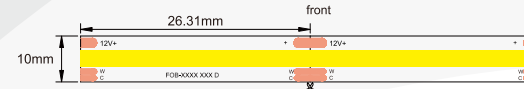

24V



2700K+6500K

LUMINOUS INTENSITY DISTRIBUTION

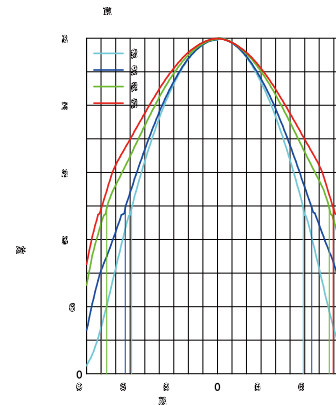
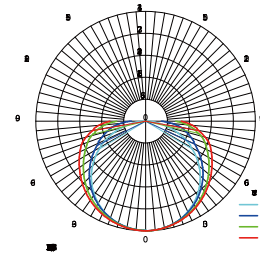



FOB756-RGB-W12 FOB768-RGB-W24

- RGB color led strip light
- Ultra-density LEDs, perfect lighting effect
- available for most RGB controller
- low glare, high effect
- Folding twist



**CE RoHS
FC IC**

Power Consumption	14W/M	
Lumen flux	/	
Input Voltage	DC24V	DC12V
Cutting Size(mm)	31.26mm	23.81mm
CRI/Ra	/	
LED Quantity/m	768LEDs	756LEDs
Size(W*L)	10mm*5000mm	
CCT(K)	Red/Green Blue	
Bend diameter	60mm	
Beam Angle	140°	
Lumen efficacy	100lm/W	
IP Class	IP20	
	IP65	silicone tube

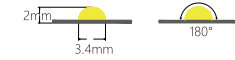
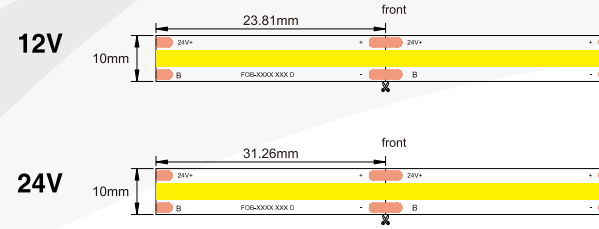

Red+Green+Blue

LUMINOUS INTENSITY DISTRIBUTION

